



# Super Air Knife



Air Knives

## Super Air Knife™

Quiet, hard-hitting curtain of air for blowoff, cleaning, drying, and cooling.



Also available from stock in 316 stainless steel and PVDF! For Corrosion Resistance

- ✓ Surprisingly Quiet! - Only 69 dBA!
- ✓ Reduced Air Consumption!
- ✓ Uniform Airflow!
- ✓ 40:1 Air Amplification!



Clean



Dry

### What Is The Super Air Knife?

EXAIR's Super Air Knife is the latest generation of our engineered air knife that dramatically reduces compressed air usage and noise when compared to other blowoffs. The Super Air Knife offers a more efficient way to clean, dry or cool parts, webs or conveyors. It delivers a uniform sheet of laminar airflow across the entire length with hard-hitting force.

Noisy blowoffs become a whisper when replaced with the compact Super Air Knife. Even at high pressures of 80 PSIG (5.5 BAR), the sound level is surprisingly quiet at 69 dBA for most applications! Air amplification ratios (entrained air to compressed air) of 40:1 are produced. Meets OSHA maximum dead-end pressure and noise requirements.



Blowoff



Cool

### Applications

- Part drying after wash
- Sheet cleaning in strip mills
- Conveyor cleaning
- Part or component cooling
- Web drying or cleaning
- Environmental separation
- Pre-paint blowoff
- Bag opening/filling operations
- Scrap removal on converting operations

### Advantages

- Quiet - 69 dBA for most applications
- Minimal air consumption
- 40:1 air amplification
- Uniform airflow across entire length
- Variable force and flow
- No moving parts - maintenance free
- Easy mounting - compressed air inlets on each end and bottom
- Compact, rugged, easy to install

- Recessed hardware
- Stock lengths to 108" (2743mm) in aluminum, 303 stainless steel, and 316 stainless steel (ss - for temperatures up to 800°F (427°C), food processing or or corrosive environments), and PVDF up to 54" (1372mm) for superior corrosion resistance.
- Special lengths available
- Unlimited system lengths of uninterrupted airflow available



## Dry

The laminar airflow of the Super Air Knife is perfect for removing moisture prior to packaging, painting, labeling, bar coding and assembly. Common applications include drying parts, rolled steel, circuit boards, webs, bottles, cans and more. Velocity is easily adjusted from a “blast” to a “breeze” with a pressure regulator.



Fast moving bottles are blown dry by (2) Model 110012 12" (305mm) Super Air Knives prior to labeling.



Model 110006 6" (152mm) Super Air Knife removes residual water from can bottoms after a rinse process, eliminating water damage to packaging and shipping materials.



Model 110054 54" (1372mm) Super Air Knife dries stamped parts that exit a washer.

## Blowoff

The Super Air Knife is ideal for blowing off chips, dirt or water from parts, webs or conveyors. It delivers a uniform sheet of air that has the same force across the entire length. There are no interruptions or “dead spots”, which means all surfaces are dried or cleaned. The Super Air Knife is available in aluminum, stainless steel, or PVDF for corrosive and high temperature applications.



A Model 110048PKI 48" (1219mm) Super Air Knife with Plumbing Kit installed uses EXAIR's Universal Air Knife Mounting System to maintain proper position for removing dust on a conveyor belt and eliminate carryover accumulation.

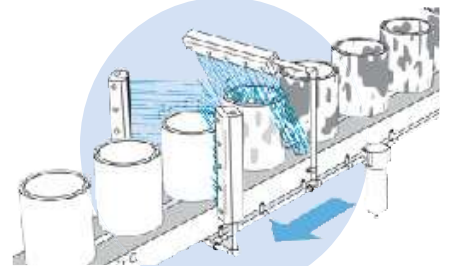

(3) Model 110012 12" (305mm) Super Air Knives blow excess honing oil off machined engine sleeves.

## Cool

Large volumes of airflow can be generated in very tight spaces due to the compact size of the Super Air Knife. Flow and force are easily controlled with a pressure regulator, allowing fast or gradual cooling. Shims can be installed if additional hard-hitting velocity is required.



A Model 110018 18" (457mm) Super Air Knife cools molten plastic following dip molding.



With a 40:1 air amplification ratio, a high volume of airflow is the result from minimal air input to keep linear induction motors from overheating.

## Open, Float, Separate

The uniform airflow exits the Super Air Knife in a perfectly straight line (does not deflect). It is ideal for opening bags and pouches, floating webs, and keeping environments separate.

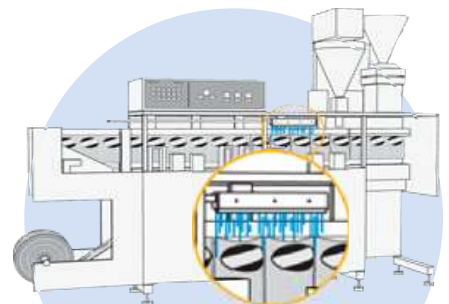

A Model 110006 6" (152mm) Super Air Knife opens pouches on a form-fill-seal-bagger.

# Super Air Knife

## How The Super Air Knife Works

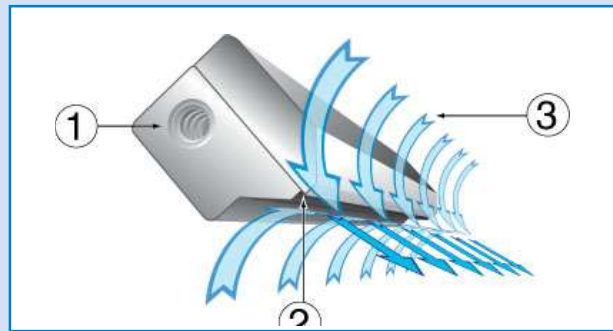

Compressed air flows through an inlet (1) into the plenum chamber of the Super Air Knife. The flow is directed to a precise, slotted orifice. As the primary airflow exits the thin slotted nozzle (2), it follows a flat surface that directs the airflow in a perfectly straight line. This creates a uniform sheet of air across the entire length of the Super Air Knife. Velocity loss is minimized and force is maximized as the room air (3) is entrained into the primary airstream at a ratio of 40:1. The result is a well defined sheet of laminar airflow with hard-hitting force and minimal wind shear.

### Intelligent Use Of Compressed Air

Almost every industrial facility has at least one compressor that is used for hundreds of different tools, equipment and operations. While most applications for compressed air present no real problems, some do. Improper use can translate into unnecessary energy costs, high noise levels and dangerous exposure of personnel to high pressure air.

### Reduce Energy Costs

The best way to cut energy costs is through proper maintenance and use of the compressed air system. Leaks and dirty filters require maintenance on a regular basis. Energy savings can also be realized when replacing outdated motors and controls with high efficiency models that often pay for themselves in a short period of time. The most important factor to dramatically boost efficiency is to use proper compressed air products. **The Super Air Knife uses only 1/3 of the compressed air of typical blowoffs.**

### Reduce Noise Levels

High noise levels are a common problem for many plants. Compressed air noise often exceeds OSHA (Occupational Safety and Health Administration) noise level exposure requirements, resulting in hearing loss to those working in close proximity. The sound level of the Super Air Knife is quiet at 69 dBA, even at high pressures of 80 PSIG (5.5 BAR). Using the Super Air Knife, it is possible to obtain hard-hitting force without the high noise.

OSHA Maximum Allowable Noise Exposure							
Hours per day (constant noise)	8	7	4	3	2	1	0.5
Sound level dBA	90	91	95	97	100	105	110

OSHA Standard 29 CFR - 1910.95 (a)

### Eliminate Harmful Dead End Pressures

Air can be dangerous when the outlet pressure of a hole, hose or copper tube is higher than 30 PSIG (2 BAR). In the event the opening is blocked by a hand or other body part, air may enter the bloodstream through the skin, resulting in a serious injury. The Super Air Knife has been engineered for safety and cannot be dead-ended. It is safe to operate at higher pressures and complies with OSHA standard 1910.242(b).

### Replacement For Expensive, Noisy Blowers

Energy conscious plants might think a blower to be a better choice due to its slightly lower electrical consumption compared to a compressor. In reality, a blower is an expensive capital expenditure that requires frequent downtime and costly maintenance of filters, belts and bearings. **Here are some important facts:**

- Filters must be replaced every one to three months.
- Belts must be replaced every three to six months.
- Blower bearings wear out quickly due to the motor that must turn at 17,000-20,000 RPM in order to generate effective airflows.
- Poorly designed seals that allow dirt and moisture infiltration along with environments above 125°F (52°C) decrease the one year bearing life.
- **Typical bearing replacement is at least once a year at a cost near \$1000.**
- Many bearings can't be replaced in the field, resulting in downtime to send the assembly back to the manufacturer.
- Many blowers generate heat, making conditions uncomfortable and difficult to use for cooling applications.

Blowers take up a lot of space and often produce sound levels that exceed OSHA noise level exposure requirements. Air volume and velocity are often difficult to control since mechanical adjustments are required.

## Compare These Blowoffs

There are a variety of ways to blow the water from the bottles shown in the photo below, but which method is best? The following comparison of drilled pipe, flat air nozzles, a blower and the Super Air Knife proves that EXAIR has the best choice for your blowoff, cooling or drying application.

Our goal for each of the blowoff choices was to use the least amount of air possible to get the job done (lowest energy and noise level). Compressed air pressure required for each was 60 PSIG (4.1 BAR) which provided adequate velocity to blow the water off. The blower used had a ten horsepower electric motor and was a centrifugal type blower at 18,000 RPM. The table at the bottom of the page summarizes the overall performance. Since your actual part may have an odd configuration, holes or sharp edges, we took sound level measurements in free air (no impinging surface).



### Drilled Pipe

This common blowoff is very inexpensive and easy to make. For this test, we used (2) drilled pipes, each with (25) 1/16" (1.6mm) diameter holes on 1/2" (13mm) centers. As shown in the test results below, the drilled pipe performed poorly. The initial cost of the drilled pipe is overshadowed by its high energy use. The holes are easily blocked and the noise level is excessive - both of which violate OSHA requirements. Velocity across the entire length was very inconsistent with spikes of air and numerous dead spots.



### Flat Air Nozzles

As shown below, this inexpensive air nozzle was the worst performer. It is available in plastic, aluminum and stainless steel from several manufacturers. The flat air nozzle provides some entrainment, but suffers from many of the same problems as the drilled pipe. Operating cost and noise level are both high. Some manufacturers offer flat air nozzles where the holes can be blocked - an OSHA violation. Velocity was inconsistent with spikes of air.



### Blower Air Knife

The blower proved to be an expensive, noisy option. As noted below, the purchase price is high. Operating cost was considerably lower than the drilled pipe and flat air nozzle, but was comparable to the EXAIR Super Air Knife. The large blower with its two 3" (76mm) diameter hoses requires significant mounting space compared to the others. Noise level was high at 90 dBA. There was no option for cycling it on and off to conserve energy like the other blowoffs. Costly bearing and filter maintenance along with downtime were also negative factors.



### EXAIR Super Air Knife

The Super Air Knife pair did an exceptional job of removing the moisture on one pass due to the uniformity of the laminar airflow. The sound level was extremely low at 69 dBA. For this application, energy use was slightly higher than the blower but can be less than the blower if cycling on and off is possible. Safe operation is not an issue since the Super Air Knife cannot be dead-ended. Maintenance costs are low since there are no moving parts to wear out.

The Super Air Knife is the low cost way to blowoff, dry, clean and cool.

**Blowoff Comparison**

Type of blowoff	PSIG	BAR	Comp. Air		Horsepower Required	Sound Level dBA	Purchase Price	Annual Electrical Cost*	Approx. Annual Maintenance Cost	First Year Cost
			SCFM	SLPM						
Drilled Pipes	60	4.1	174	4,924	35	91	\$50	\$4,508	\$920	\$5,478
Flat Air Nozzles	60	4.1	257	7,273	51	102	\$300	\$6,569	\$1,450	\$8,319
Blower Air Knife	3	0.2	N/A	N/A	10	90	\$7,000	\$1,288	\$1,500	\$9,788
Super Air Knife	60	4.1	55	1,557	11	69	\$720	\$1,417	\$300	\$2,437

\*Based on national average electricity cost of 8.3 cents per kWh. Annual cost reflects 40 hours per week, 52 weeks per year.

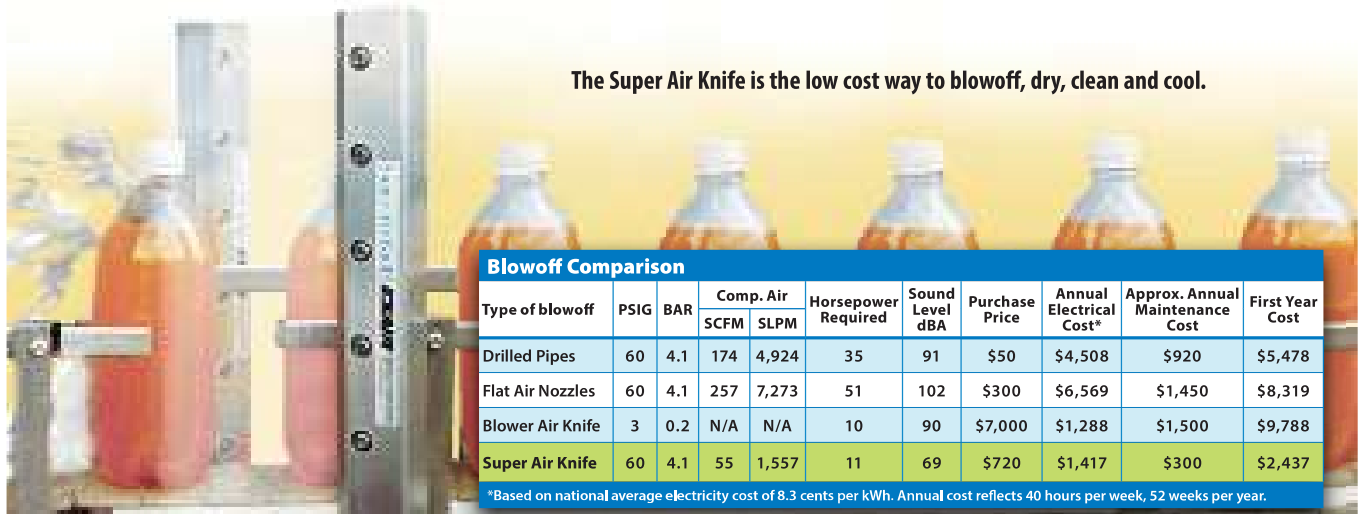

# Super Air Knife

Super Air Knife Performance with .002" (0.05mm) thick shim installed

Pressure Supply		Air Consumption per Inch (25mm)		Velocity @ 6" (152mm) from target		Sound Level @ 3' (914mm)	Force per Inch (25mm) @ 6" (152mm) from target	
PSIG	BAR	SCFM	SLPM	FPM	M/S	dBA	OUNCES	GRAMS
20	1.4	1.1	31	5,000	25.4	57	0.6	17
40	2.8	1.7	48	7,000	35.6	61	1.1	31
60	4.1	2.3	65	9,600	48.8	65	1.8	51
80	5.5	2.9	82	11,800	59.9	69	2.5	71
100	6.9	3.5	99	13,500	68.5	72	3.2	91

## Airflow Pattern

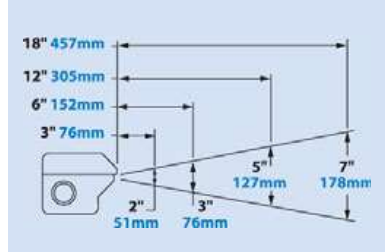

12" (305mm) Super Air Knife tested

## Holes Drilled In Pipe

Pressure Supply		Air Consumption 1/16" (1.59mm) dia. hole		Air Consumption 3/32" (2.38mm) dia. hole		Air Consumption 1/8" (3.18mm) dia. hole		Air Consumption 3/16" (4.76mm) dia. hole		Air Consumption 1/4" (6.35mm) dia. hole	
PSIG	BAR	SCFM	SLPM	SCFM	SLPM	SCFM	SLPM	SCFM	SLPM	SCFM	SLPM
20	1.4	1.4	40	3.5	99	6.4	181	14.5	410	25	710
40	2.8	2.2	62	5.4	153	10.2	289	22.9	648	40	1,132
60	4.1	3.0	85	7.4	209	14	396	31	877	54	1,528
80	5.5	3.8	108	9.4	266	17.5	495	39.5	1,118	69	1,953
100	6.9	4.6	130	11.5	326	21.5	609	47.5	1,344	84	2,363

## How To Calculate Air Savings:

The chart at the top of the page shows the air consumption of a Super Air Knife **per inch of length** (25mm) at various pressures. Comparable data is given for holes drilled in pipe.

### To Determine Air Consumption for the Drilled Pipe

1. Determine the size of existing holes and supply pressure. From the chart, find air consumption per hole.
2. Multiply air consumption per hole times the number of holes to obtain total air consumption.

### To Determine Air Consumption for the Super Air Knife

1. From the chart, find the air consumption per inch (25mm) at supply pressure and multiply by number of inches required.

### Example:

1. Existing blowoff is 18" long pipe with 1/16" diameter holes on 1/2" spacing (37 holes), 80 PSIG supply. Air consumption from chart is 3.8 SCFM per hole. Total air consumption is 37 x 3.8 = 140.6 SCFM (3,981 SLPM).
2. Use 18" (457mm) Super Air Knife with standard .002" gap and 80 PSIG supply. Air consumption from chart is 2.9 SCFM per inch. Total air consumption is 18 x 2.9 = 52.2 SCFM (1,478 SLPM).
3. Compressed air saved = 140.6 SCFM - 52.2 SCFM = 88.4 SCFM (2,503 SLPM).
4. Most large plants know their air cost. If you don't know your actual cost, a reasonable average to use is \$0.25 per 1,000 SCF (28,329 SL).
5. Dollars saved per hour = SCFM saved x 60 minutes x cost/1,000 SCF = 88.4 x 60 x \$0.25/1,000 = \$1.33/hour = \$53.20 per 40 hour week = \$2,766.40 per year savings

## Super Air Knife Specifications

The Super Air Knife is available in standard lengths of 3", 6", 9", 12", 18", 24", 30", 36", 42", 48", 54", 60", 72", 84", 96" and 108". **Special lengths and unlimited system lengths are available.** Any number of Super Air Knives may be installed across a given area.

**Compressed Air Inlets:** A Super Air Knife has compressed air inlets on each end and the bottom. Knives 24"-47" should use the 2 inlets at opposite ends of the knife. Knives 48"-59" use 2 inlets at opposite ends plus 1 near the middle on the bottom of the knife. Knives 60"-83" use 2 inlets at opposite ends plus 2 inlets equally spaced on the bottom of the knife. Knives 84" and longer use 2 inlets at opposite ends plus 3 inlets equally spaced on the bottom of the knife.

**Filtration:** The use of clean air is essential. Kits include an automatic drain filter with a 5 micron filter element that is sized properly for flow.

**Materials of Construction:** The Super Air Knife is available from stock in aluminum, Type 303 stainless steel, Type 316 stainless steel and PVDF. Other materials are available on special order.

**Mounting:** The Universal Air Knife Mounting System is shown on page 29. The Super Air Knife can be supported by the compressed air pipe. Tapped holes (1/4"-20) on the bottom are also provided.

**Regulation:** A pressure regulator on the compressed air supply provides infinite control of flow, force and air consumption. Kits include a pressure regulator that is sized properly for flow.

**Shim Sets:** The compressed air exhausts through a gap which is set with a shim. Force and flow may be increased by adding shims. Shim sets for aluminum Super Air Knives include a .001" (0.03mm) **Amber color** [Amber], .003" (0.08mm) **Green color** [Green], and .004" (0.10mm) thick **Tan color** [Tan] plastic shims. A **Red color** [Red] .002" (0.05mm) thick shim comes installed in the Super Air Knife. Shim sets for stainless steel Super Air Knives include (3) .002" (0.05mm) stainless steel shims. PVDF Super Air Knife shim sets include (3) .002" (0.05mm) PTFE shims.

## Changing Performance By Adding Shims

The Super Air Knife is shipped with a Red color  .002" (0.05mm) thick shim installed, which works best for most applications. There are, however, some situations that require more force and flow. Thicker shims will increase the gap opening which offers higher velocity and harder hitting force. Air consumption and noise will be slightly higher. Shim sets are included with all kits or can be purchased separately.



Kits include a Super Air Knife, shim set, filter separator and pressure regulator (with coupler).

## Special Super Air Knives

EXAIR manufactures special Super Air Knives suited to specific application requirements. The shape, dimensions and materials of construction can be modified to fit existing machines and environments.

The curved stainless steel Super Air Knife (*shown top right*) was manufactured for a laboratory that uses the force of the airflow to hold test tubes in place on a rotating index table. They were able to eliminate the mechanical clips and latches that slowed the test tube removal. This holding method minimized risk of tube breakage and eliminated any chance of puncturing the technician's rubber gloves.

EXAIR manufactures special Super Air Knives made of plastic. These products are engineered to work under normal operating pressures, providing the same performance as their aluminum and stainless steel counterparts.

The PVC Super Air Knife (*shown 2nd from top right*) was manufactured for a picture tube plant. The softer material was less likely to scratch the picture tube surface and was chemically resistant to the phosphorus which coated the inside.

The flat Super Air Knife (*shown 3rd from top right*) is used in a molding machine for integrated circuit chips. Prior to molding the black plastic shells around the silicon wafers, they blow the mold cavity clean of any fine plastic fibers left by the previous cycle. The flat design constructed of corrosion resistant stainless steel was made to fit the tight space of the molding machine.

The double-sided Super Air Knife (*shown 2nd from bottom right*) provides two uniform sheets of air in opposite directions. It is ideal for blowing water from two or more columns of stacked parts (like printed circuit boards) as they are lifted out of a bath or the open halves of a mold. Each side operates independently.

The Super Air Knife (*shown bottom right*) can be modified to include extra mounting holes to suit your application.



A special curved stainless steel Super Air Knife holds test tubes in place on a rotating index table.



A PVC Super Air Knife designed to withstand a phosphorus environment.

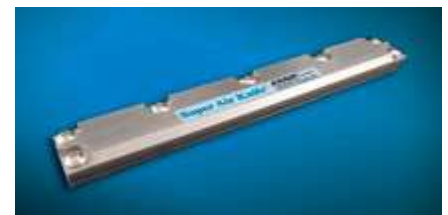

A flat Super Air Knife, only 11/16" thick, blows plastic fibers from a mold used to make integrated circuit chips.



The double-sided Super Air Knife provides two uniform sheets of laminar airflow.



Stainless steel Super Air Knife modified to include extra mounting holes.

# Super Air Knife

## Many Lengths Available From Stock in Four Materials

EXAIR's Super Air Knives are available from stock in many lengths and your choice of four materials. The force, flow and air pattern stay the same for each construction.

### Aluminum

The aluminum Super Air Knife is suited to a wide variety of environments where corrosion or contamination is not a factor. The aircraft grade aluminum construction with plastic shim is very durable for general purpose applications. Stainless steel screws are used to eliminate corrosion in damp locations. It can withstand temperatures up to 180°F (82°C).

### Type 303 Stainless Steel

This is the most common grade of stainless steel. It offers good strength and is best suited to mildly corrosive environments. It can withstand temperatures up to 800°F (427°C).

### Type 316 Stainless Steel

Some applications require better corrosion resistance than offered by Type 303 stainless steel. Type 316 stainless steel offers excellent corrosion resistance, better strength properties and resists pitting. These factors are important to manufacturers of food, pharmaceutical and surgical products that need to minimize contamination by the metal. It can withstand temperatures up to 800°F (427°C).

### PVDF (Polyvinylidene Fluoride)

EXAIR's Super Air Knife is also available from stock in PVDF (Polyvinylidene Fluoride). PVDF offers superior strength and is resistant to UV light, inorganic chemicals, solvents, ozone, weather, fungi, chlorinated hydrocarbons, highly corrosive acids, weak bases and salts. The PVDF Super Air Knife uses PTFE shims, Type 316 Stainless Steel pipe plugs, and Hastelloy® C-276 alloy screws to withstand harsh environments. The PVDF Super Air Knife is suitable for manufacturing processes that involve electroplating, solar cells, lithium ion batteries, transfer of acids and caustic chemicals, brine, solvent recovery, semiconductors, and medical devices. It can withstand temperatures up to 275°F (135°C).



PVDF Super Air Knives provide superior corrosion resistance.

HASTELLOY is a registered trademark of Haynes International, Inc.

## Super Air Knife Replaces Fan Cooling

**The Problem:** A manufacturer of automotive electronics had a problem cooling computers as they exited a wave solder machine. In order to be handled and tested, the computers had to first be cooled to 81°F (27°C). Initially, they had tried banks of 6" (152mm) diameter axial fans across the 8' (2.5m) length of the cooling conveyor. It consisted of 16 fans blowing down from the top and 16 fans blowing up from the bottom at 7" (178mm) away from the surface. After traveling the full length of the conveyor with the fans running at full force (a five minute duration), the computers were still 108°F (42°C). Quality control personnel sat with an unacceptable backlog of computers waiting to be tested.

**The Solution:** The company removed the top and bottom fan banks and replaced them with (3) **Model 110012 12" (305mm) Super Air Knives** that were evenly spaced across the cooling section. Each Super Air Knife was angled so the computer and heat sink received the constant rush of airflow. **With the conveyor at the same speed 1.6 FPM (0.5m/min), and Super Air Knives at only 40 PSIG (2.8 BAR), the computers were cooled to 81°F (27°C) in 90 seconds!**

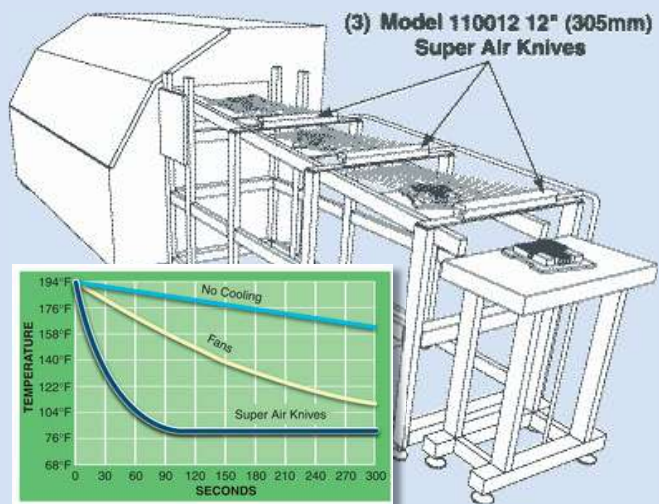

**Comment:** The laminar airflow of the Super Air Knives was the key to success in this application. Fan cooling could only provide random spikes of air at moderate velocities. **The uniform sheet of air from the Super Air Knife quietly swept the heat away within the first 2' (610mm) of the conveyor.** Low air consumption and the compact size of the Super Air Knife were an added bonus.

## Air Shielding a Laser Lens

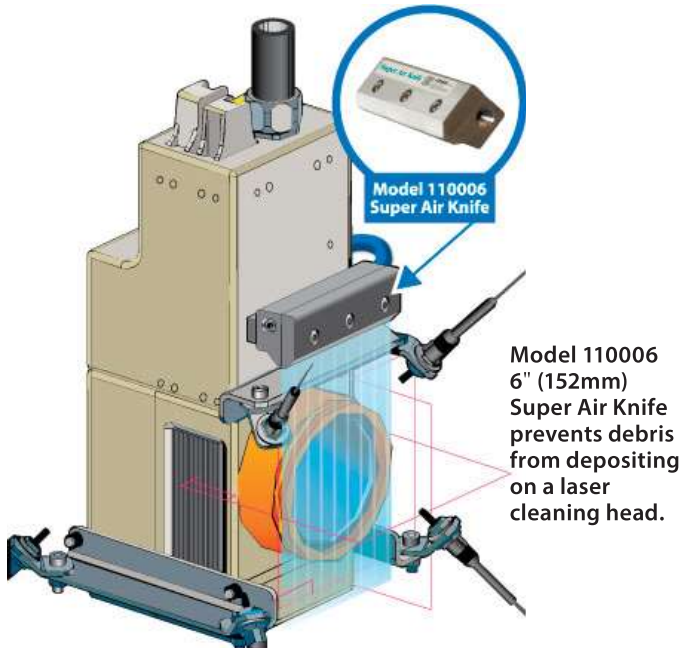

**The Problem:** A dirty lens can affect the quality of cameras, sensors and lasers. Today's visual inspection systems are highly accurate tools used to monitor dimensions, temperature, finish quality, labeling and much more. These products require clean lenses in

order to provide the proper feedback to operators or other machinery within the process. The laser lens to the left is integral to a laser cleaning operation where a laser is used to clear away debris and provide a fresh surface. The laser cleaning operation in this case was creating debris which flew up and deposited onto the laser lens. Debris on the lens could affect the laser's cleaning quality or become burned upon the lens and create the need for a replacement lens.

**The Solution:** A **Model 110006 6" (152mm) Super Air Knife** was installed just above the laser lens to blow air down and across the lens. The sheet of air created an invisible barrier the contaminants could not penetrate and kept them from depositing onto the lens. The quality of the laser cleaning has been consistently good and the need for replacement lenses due to debris deposition has been eliminated.

**Comment:** An air barrier is a common application for a Super Air Knife and can create a non-contact wiper with little or no obstruction. They have been used in similar applications to prevent debris from getting to many different sensors or cameras, to retain heat within an oven, or to deflect mist from a machine tool.

## Bakery Creates Clean Break In Icing

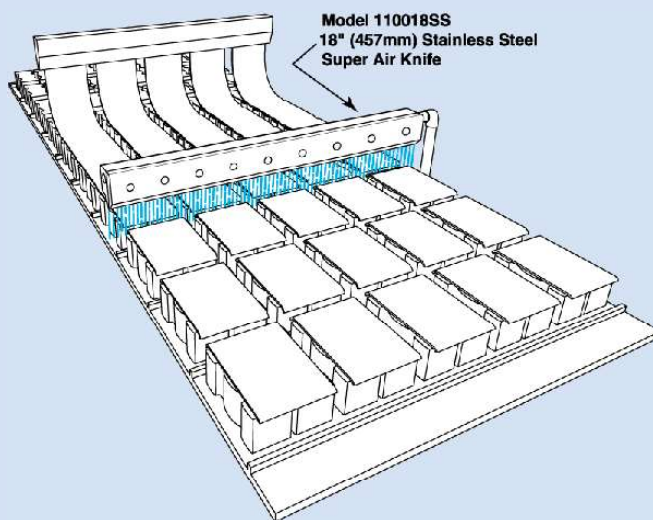

**The Problem:** A bakery had a problem applying the icing to their snack cakes. As the baked sponge cakes moved down the conveyor, a continuous ribbon of icing was applied to the individual cakes. Trying to make a clean

break in the icing was next to impossible. Mechanical blades required constant cleaning. Compressed air through a series of holes in drilled pipe used too much air, was noisy and didn't make a clean break in the icing.

**The Solution:** A **Model 110018SS 18" (457mm) Stainless Steel Super Air Knife** was installed across the conveyor. A photo eye is used to detect the space between the cakes and turn the compressed air on at the precise moment to apply uniform airflow and velocity against the ribbon of icing, creating a nice, clean break.

**Comment:** The Stainless Steel Super Air Knife was the best choice for this application. Since there was no contact with the icing, no additional cleaning was required. **The laminar flow of the Super Air Knife has uniform velocity across the entire length and broke the ribbon of icing evenly.** This would never have been possible with the spikes of air from a drilled pipe, nozzles or a blower.



# Super Air Knife

## Smoke Containment During Engine Test

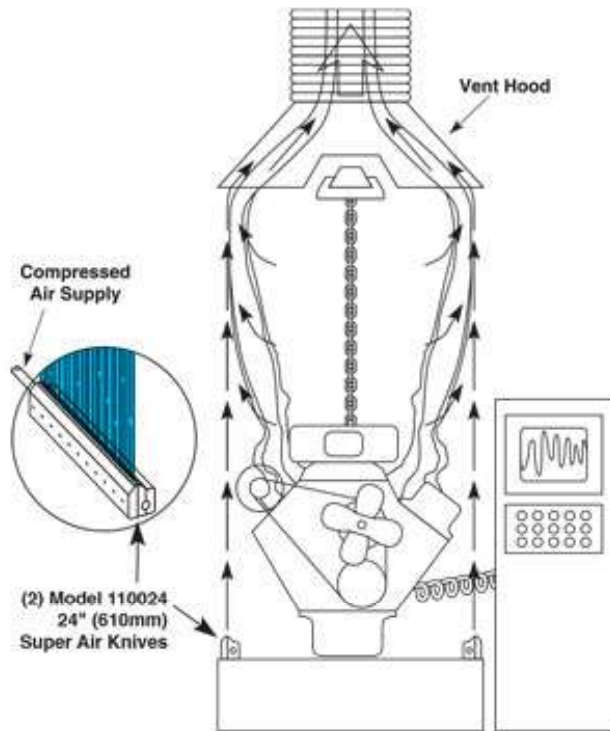

**The Problem:** The last step in an engine assembly process is “burn-in” on a test stand. Each engine is connected to a dynamometer and run for a period of one to five minutes. Residual machining oil on the head produced smoke during the test, and the vent hood at the top of the stand had insufficient capacity to contain it.

**The Solution:** A Model 110024 24" (610mm) Super Air Knife was mounted on both sides of the test stand. The sheet or “wall” of air produced by the Super Air Knife, captured, contained and diluted the smoke while directing it towards the vent hood. The environmental problem was solved without obstructing the technician's observation of, or access to the stand.

**Comment:** The use of the Super Air Knife for containment and separation is becoming increasingly common. The advantage, as illustrated here, is the ability of the Super Air Knife to create a screen or barrier with no obstruction. Other typical applications in this mode are:

- Retaining heat in curing and drying ovens
- Protecting workers from coolant splatter
- Isolating industrial camera lenses from airborne contaminants

## Drying Crates Following a Washing Operation

**The Problem:** A bottling plant places their filled bottles into plastic crates as a final step of their process. When the empty plastic crates are returned from the various retail markets, they must first be washed and sanitized prior to using them again. When the bottler put the crates through the washer, they exited the final rinse dripping wet. Bottles placed in the wet crates were eventually covered with water spots and many product labels were ruined.

**The Solution:** The company installed (3) Model 110018 18" (457mm) Super Air Knives to completely surround and blowoff the crates. Each Super Air Knife was placed on an angle with the sheet of air blowing against the travel of the crates and directing the water downward toward the floor. The crates were dried and the bottles could be loaded immediately.

**Comment:** Super Air Knives were the best choice for this application. The uniform sheet of laminar airflow provided complete coverage so there were no dead spots



Three Model 110018 18" (457mm) Super Air Knives completely surround and blowoff crates so they can be loaded immediately.

when blowing across the inside and outside surfaces of the crate. The mounting used made it easy to rearrange and adjust the Super Air Knife depending on the size of the crate. Other companies have used a similar arrangement of the Super Air Knives to blowoff car batteries, blocks of cheese, milk cartons, buckets, and more.

## Universal Air Knife Mounting System

### Provide Precise Positioning For Your Air Knife!

The Model 9060 Universal Air Knife Mounting System is used to provide secure, precise positioning for any of the EXAIR Air Knives. The Air Knife can quickly and easily be moved within close proximity of the part to improve effectiveness. It can be mounted on the top or bottom of most Air Knives (Super, Standard and Full-Flow Air Knives). The Mounting System has a durable, stainless steel construction that is suitable for a variety of industrial applications.

The mounting system can also be used with EXAIR Static Eliminators. For the Gen4 Super Ion Air Knife, it can be mounted on the top. Bottom mounting is possible on Gen4 Super Ion Air Knives that are 18" or longer. For the Gen4 Standard Ion Air Knife, it can be top mounted on any length. Bottom mounting is possible on Gen4 Standard Ion Air Knives that are 9" or longer.

The Mounting System can be articulated into any position and provides a maximum extension of 30". A 1/2" diameter hole is required for mounting. Alternatively, the bolt can be threaded directly into a 1/2"-13 tapped hole. For any style Air Knife that is 24" to 54", use (2) Universal Air Knife Mounting Systems. For knives 55" - 71", use (3). For 72" - 95", use (4). For knives 96" and over, use (5).



**Model 9060 Universal Air Knife Mounting System**

### Air Knife Mounting System

#### Model # Description

<b>9060</b>	Universal Air Knife Mounting System
-------------	-------------------------------------

## Air Knife Plumbing Kits

Super Air Knives that are 24" or longer must be supplied with compressed air at multiple inlets on the Air Knife. EXAIR's Air Knife Plumbing Kits make it easy to ensure proper airflow to each inlet. They provide properly sized compressed air hose or pipe and fittings to interconnect the bottom or end compressed air inlets for best performance. Plumbing kits for aluminum Super Air Knives include a pressure gauge to monitor pressure at the Super Air Knife, which is an indication of proper air supply. They also include nitrile/PVC hose and brass fittings. Plumbing kits for stainless steel Super Air Knives include cut to length type 316 stainless steel pipe and fittings and will also work on PVDF Super Air Knives.



**Model 9076, 9077, 9078 and 9079 Plumbing Kits work with Aluminum Super Air Knives and provide the hose and fittings to couple the inlets for best performance.**

### Plumbing Kits for Aluminum Super Air Knives

Model #	Description
<b>9076</b>	Air Knife Plumbing Kit - for lengths up to 42" (1067mm)
<b>9077</b>	Air Knife Plumbing Kit - for lengths 48" - 54" (1219 - 1372mm)
<b>9078</b>	Air Knife Plumbing Kit - for lengths 60" - 84" (1524 - 2134mm)
<b>9079</b>	Air Knife Plumbing Kit - for lengths 90" - 108" (2286 - 2743mm)



**Stainless Steel Plumbing Kits work with Stainless Steel Super Air Knives and provide the pipe and fittings to couple the inlets for best performance.**

### Plumbing Kits for Stainless Steel and PVDF Super Air Knives

Model #	Description
<b>9240</b>	For 24" (610mm) length
<b>9241</b>	For 30" (762mm) length
<b>9242</b>	For 36" (914mm) length
<b>9243</b>	For 42" (1067mm) length
<b>9244</b>	For 48" (1219mm) length
<b>9245</b>	For 54" (1372mm) length
<b>9246</b>	For 60" (1524mm) length
<b>9247</b>	For 72" (1829mm) length
<b>9248</b>	For 84" (2134mm) length
<b>9249</b>	For 96" (2438mm) length
<b>9250</b>	For 108" (2743mm) length

## Coupling Bracket Kits

Some applications require a Super Air Knife that is longer than our 108" (2743mm) length. Coupling Bracket Kits that join two Super Air Knives together are available. The kit includes two rigid plates along with the assembly screws. The bottom plate is supplied with a hole to access the bottom compressed air inlets. All models include stainless steel screws.



**The Model 110900 Coupling Bracket Kit is used to join two aluminum Super Air Knives.**

### Air Knife Coupling Bracket Kit

Model #	Description
<b>110900</b>	Aluminum Coupling Bracket Kit
<b>110900SS</b>	Type 303 Stainless Steel Coupling Bracket Kit
<b>110900SS-316</b>	Type 316 Stainless Steel Coupling Bracket Kit

# Super Air Knife

## Aluminum Super Air Knife Dimensions

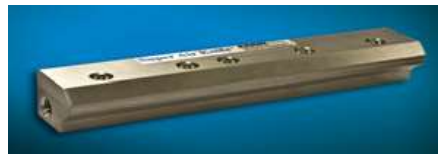
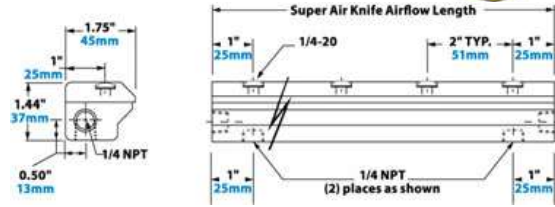

**ONE  
PIECE**  
CONSTRUCTION

DOWNLOAD drawings at EXAIR.com

## Type 303 and 316 Stainless Steel Super Air Knife Dimensions

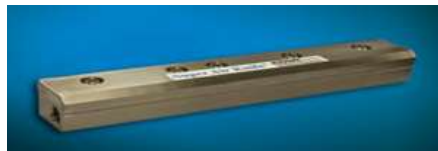
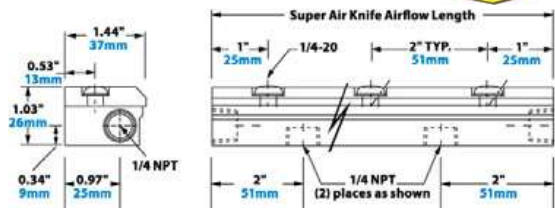

**ONE  
PIECE**  
CONSTRUCTION

DOWNLOAD drawings at EXAIR.com

## PVDF Super Air Knife Dimensions

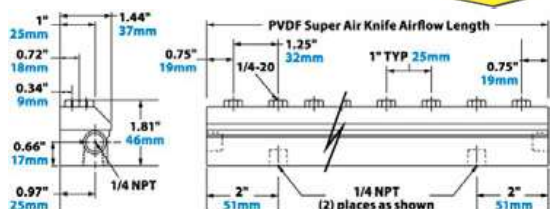

**ONE  
PIECE**  
CONSTRUCTION

DOWNLOAD drawings at EXAIR.com

### Super Air Knife Only

Airflow Length	Aluminum Model	Type 303SS Model	Type 316SS Model	PVDF Model
3" (76mm)	110003	110003SS	110003SS-316	110003-PVDF
6" (152mm)	110006	110006SS	110006SS-316	110006-PVDF
9" (229mm)	110009	110009SS	110009SS-316	110009-PVDF
12" (305mm)	110012	110012SS	110012SS-316	110012-PVDF
18" (457mm)	110018	110018SS	110018SS-316	110018-PVDF
24" (610mm)	110024	110024SS	110024SS-316	110024-PVDF
30" (762mm)	110030	110030SS	110030SS-316	110030-PVDF
36" (914mm)	110036	110036SS	110036SS-316	110036-PVDF
42" (1067mm)	110042	110042SS	110042SS-316	110042-PVDF
48" (1219mm)	110048	110048SS	110048SS-316	110048-PVDF
54" (1372mm)	110054	110054SS	110054SS-316	110054-PVDF
60" (1524mm)	110060	110060SS	110060SS-316	N/A
72" (1829mm)	110072	110072SS	110072SS-316	N/A
84" (2134mm)	110084	110084SS	110084SS-316	N/A
96" (2438mm)	110096	110096SS	110096SS-316	N/A
108" (2743mm)	110108	110108SS	110108SS-316	N/A

### Super Air Knife Kits

Kits include a Super Air Knife, shim set, filter separator and pressure regulator (with coupler).

Airflow Length	Aluminum Model	Type 303SS Model	Type 316SS Model	PVDF Model
3" (76mm)	110203	110203SS	110203SS-316	110203-PVDF
6" (152mm)	110206	110206SS	110206SS-316	110206-PVDF
9" (229mm)	110209	110209SS	110209SS-316	110209-PVDF
12" (305mm)	110212	110212SS	110212SS-316	110212-PVDF
18" (457mm)	110218	110218SS	110218SS-316	110218-PVDF
24" (610mm)	110224	110224SS	110224SS-316	110224-PVDF
30" (762mm)	110230	110230SS	110230SS-316	110230-PVDF
36" (914mm)	110236	110236SS	110236SS-316	110236-PVDF
42" (1067mm)	110242	110242SS	110242SS-316	110242-PVDF
48" (1219mm)	110248	110248SS	110248SS-316	110248-PVDF
54" (1372mm)	110254	110254SS	110254SS-316	110254-PVDF
60" (1524mm)	110260	110260SS	110260SS-316	N/A
72" (1829mm)	110272	110272SS	110272SS-316	N/A
84" (2134mm)	110284	110284SS	110284SS-316	N/A
96" (2438mm)	110296	110296SS	110296SS-316	N/A
108" (2743mm)	1102108	1102108SS	1102108SS-316	N/A





### Deluxe Super Air Knife Kits

Kits include a Super Air Knife, EFC, Universal Mounting System, shim set, filter separator and pressure regulator (with coupler).

Airflow Length	Aluminum Model	Type 303SS Model	Type 316SS Model	PVDF Model
3" (76mm)	110203DX	110203SSDX	110203SSDX-316	N/A
6" (152mm)	110206DX	110206SSDX	110206SSDX-316	N/A
9" (229mm)	110209DX	110209SSDX	110209SSDX-316	N/A
12" (305mm)	110212DX	110212SSDX	110212SSDX-316	N/A
18" (457mm)	110218DX	110218SSDX	110218SSDX-316	N/A
24" (610mm)	110224DX	110224SSDX	110224SSDX-316	N/A
30" (762mm)	110230DX	110230SSDX	110230SSDX-316	N/A
36" (914mm)	110236DX	110236SSDX	110236SSDX-316	N/A
42" (1067mm)	110242DX	110242SSDX	110242SSDX-316	N/A
48" (1219mm)	110248DX	110248SSDX	110248SSDX-316	N/A
54" (1372mm)	110254DX	110254SSDX	110254SSDX-316	N/A
60" (1524mm)	110260DX	110260SSDX	110260SSDX-316	N/A
72" (1829mm)	110272DX	110272SSDX	110272SSDX-316	N/A
84" (2134mm)	110284DX	110284SSDX	110284SSDX-316	N/A
96" (2438mm)	110296DX	110296SSDX	110296SSDX-316	N/A
108" (2743mm)	1102108DX	1102108SSDX	1102108SSDX-316	N/A

# Super Air Knife

## Super Air Knife Shim Sets

Shim sets for aluminum Super Air Knives include a .001" (0.03mm) Amber color , .003" (0.08mm) Green color , and .004" (0.10mm) thick Tan color  plastic shim. A Red color  .002" (0.05mm) thick shim comes installed in the Super Air Knife. Shim sets for stainless steel Super Air Knives include (3) .002" (0.05mm) thick stainless steel shims. PVDF Super Air Knife shim sets include (3) .002" (0.05mm) PTFE shims.



Force and flow can be increased by installing additional shims that open the air gap.

Special length Super Air Knives are available. Magnetic bases with Stay Set™ flexible hoses are also available for smaller Super Air Knives. Please contact our factory.

Airflow Length	Aluminum Model	Type 303SS Model	Type 316SS Model	PVDF Model
3" (76mm)	110303	110303SS	110303SS-316	110303-PVDF
6" (152mm)	110306	110306SS	110306SS-316	110306-PVDF
9" (229mm)	110309	110309SS	110309SS-316	110309-PVDF
12" (305mm)	110312	110312SS	110312SS-316	110312-PVDF
18" (457mm)	110318	110318SS	110318SS-316	110318-PVDF
24" (610mm)	110324	110324SS	110324SS-316	110324-PVDF
30" (762mm)	110330	110330SS	110330SS-316	110330-PVDF
36" (914mm)	110336	110336SS	110336SS-316	110336-PVDF
42" (1067mm)	110342	110342SS	110342SS-316	110342-PVDF
48" (1219mm)	110348	110348SS	110348SS-316	110348-PVDF
54" (1372mm)	110354	110354SS	110354SS-316	110354-PVDF
60" (1524mm)	110360	110360SS	110360SS-316	N/A
72" (1829mm)	110372	110372SS	110372SS-316	N/A
84" (2134mm)	110384	110384SS	110384SS-316	N/A
96" (2438mm)	110396	110396SS	110396SS-316	N/A
108" (2743mm)	1103108	1103108SS	1103108SS-316	N/A

## Super Air Knives with Plumbing Kits Installed

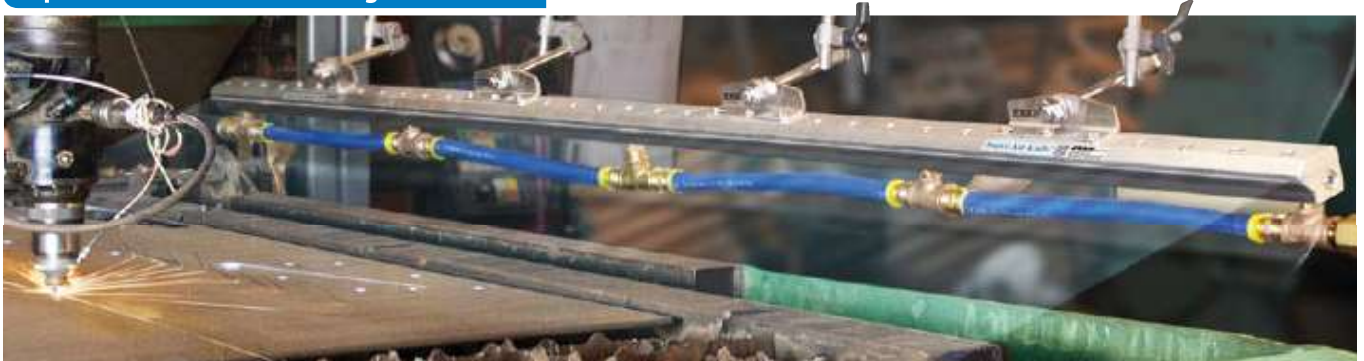

EXAIR offers Super Air Knives in lengths from 24" (610mm) through 108" (2743mm) with Plumbing Kits that are shipped fully assembled. All components have been properly sized to obtain the best performance from the Super Air Knife.

### Super Air Knife with Plumbing Kit

Super Air Knife with Plumbing Kit installed.

Airflow Length	Aluminum Model	Type 303SS Model	Type 316SS Model
24" (610mm)	110024PKI	110024SSPKI	110024SS-316PKI
30" (762mm)	110030PKI	110030SSPKI	110030SS-316PKI
36" (914mm)	110036PKI	110036SSPKI	110036SS-316PKI
42" (1067mm)	110042PKI	110042SSPKI	110042SS-316PKI
48" (1219mm)	110048PKI	110048SSPKI	110048SS-316PKI
54" (1372mm)	110054PKI	110054SSPKI	110054SS-316PKI
60" (1524mm)	110060PKI	110060SSPKI	110060SS-316PKI
72" (1829mm)	110072PKI	110072SSPKI	110072SS-316PKI
84" (2134mm)	110084PKI	110084SSPKI	110084SS-316PKI
96" (2438mm)	110096PKI	110096SSPKI	110096SS-316PKI
108" (2743mm)	1100108PKI	1100108SSPKI	1100108SS-316PKI

### Super Air Knife Kit with Plumbing Kit

Super Air Knife Kit with Plumbing Kit installed.

Airflow Length	Aluminum Model	Type 303SS Model	Type 316SS Model
24" (610mm)	110224PKI	110224SSPKI	110224SS-316PKI
30" (762mm)	110230PKI	110230SSPKI	110230SS-316PKI
36" (914mm)	110236PKI	110236SSPKI	110236SS-316PKI
42" (1067mm)	110242PKI	110242SSPKI	110242SS-316PKI
48" (1219mm)	110248PKI	110248SSPKI	110248SS-316PKI
54" (1372mm)	110254PKI	110254SSPKI	110254SS-316PKI
60" (1524mm)	110260PKI	110260SSPKI	110260SS-316PKI
72" (1829mm)	110272PKI	110272SSPKI	110272SS-316PKI
84" (2134mm)	110284PKI	110284SSPKI	110284SS-316PKI
96" (2438mm)	110296PKI	110296SSPKI	110296SS-316PKI
108" (2743mm)	1102108PKI	1102108SSPKI	1102108SS-316PKI

# Super Air Knife

## Accessories

Model #	Description	Model #	Description
9001	Auto Drain Filter Separator, 3/8 NPT, 65 SCFM (1,841 SLPM)	9067	Pressure Regulator, 1-1/4 NPT, 600 SCFM (16,990 SLPM)
9032	Auto Drain Filter Separator, 1/2 NPT, 90 SCFM (2,549 SLPM)	9020	Solenoid Valve, 120V, 50/60Hz, 1/4 NPT, 40 SCFM (1,133 SLPM)
9002	Auto Drain Filter Separator, 3/4 NPT, 220 SCFM (6,230 SLPM)	9034	NEMA 4/4X Solenoid Valve, 120V, 50/60Hz, 1/2 NPT, 100 SCFM (2,832 SLPM)
9066	Auto Drain Filter Separator, 1-1/4 NPT, 400 SCFM (11,327 SLPM)	9036	NEMA 4/4X Solenoid Valve, 120V, 50/60Hz, 3/4 NPT, 200 SCFM (5,664 SLPM)
9005	Oil Removal Filter, 3/8 NPT, 15-37 SCFM (425-1,048 SLPM)	9065	NEMA 4/4X Solenoid Valve, 24VDC, 1 NPT, 350 SCFM (9,911 SLPM)
9006	Oil Removal Filter, 3/4 NPT, 50-150 SCFM (1,416-4,248 SLPM)	9060	Universal Air Knife Mounting System
9010	Oil Removal Filter, 1-1/2 NPT, 130-310 SCFM (3,679-8,773 SLPM)	110900	Aluminum Coupling Bracket Kit
9008	Pressure Regulator, 1/4 NPT, 50 SCFM (1,416 SLPM)	110900SS	Type 303 Stainless Steel Coupling Bracket Kit
9033	Pressure Regulator, 1/2 NPT, 100 SCFM (2,832 SLPM)	110900SS-316	Type 316 Stainless Steel Coupling Bracket Kit
9009	Pressure Regulator, 3/4 NPT, 220 SCFM (6,230 SLPM)		



EXAIR's Universal Air Knife Mounting System allows for easy positioning of all EXAIR Air Knives. See page 29 for details.



EXAIR's Plumbing Kits provide properly sized compressed air hose or pipe, and fittings to eliminate pressure loss and provide peak performance. See page 29 and 31 for details.

## Which Air Knife Is Best For Your Application?

EXAIR manufactures the Super Air Knife, Standard Air Knife and Full-Flow Air Knife. The table below provides a quick comparison of the three styles.

**The Super Air Knife** provides the best performance with a 40:1 air amplification ratio, making it the most efficient. It is the best choice for all applications. The Super Air Knife has a laminar airstream that is uniform, forceful and quiet. Velocity is the highest of all three air knives. Air consumption is lowest of all three air knives. Compressed air inlets are provided on each end and on the bottom. Multiple Super Air Knives can be mounted "end to end" for longer lengths of uninterrupted airflow.

**The Standard Air Knife** provides good performance with a 30:1 air amplification ratio that is less efficient than the Super Air Knife. It is a good choice when a less expensive alternative is required. The Standard Air Knife has an airflow that is also uniform and forceful. It is louder and uses more compressed air than the Super Air Knife. Compressed air inlets are provided on each end. Overall length is 1" (25mm) longer than the airflow length.

**The Full-Flow Air Knife** provides good performance with a 30:1 air amplification ratio. The Full-Flow Air Knife is the least expensive and is a good choice for tight spaces. Force is less than the other two styles. Air consumption and sound level falls between that of the Super Air Knife and the Standard Air Knife. Compressed air inlet(s) are provided on the rear. Inlets are available on each end at a small additional charge, however they are not recommended for applications where uniform flow across the length is required.



Super Air Knife (shown left)  
Standard Air Knife (shown middle)  
Full-Flow Air Knife (shown right)

### Super Air Knife

- Best choice for all applications
- Lowest operating cost
- Highest efficiency (saves most air)
- Quietest
- 40:1 air amplification ratio
- Compressed air inlets on each end and the bottom
- Airflow length and overall length are the same

### Standard Air Knife

- Good choice, lower purchase price
- Highest operating cost of the three
- Good velocity
- Higher dBA rating
- Compressed air inlets on each end
- Overall length is 1" (25mm) longer than the airflow length

### Full-Flow Air Knife

- Good choice, lowest purchase price
- Higher operating cost than the Super Air Knife
- Smallest size
- Airflow length and overall length are the same

	Air Consumption		Velocity		Force per Inch (25mm)		Sound Level	Amp.
	SCFM	SLPM	FPM	M/S	Ozs	Grams	dBA	RATIO
6" (152mm) Super Air Knife	17.4	492	11,800	59.9	2.5	71	69	40:1
6" (152mm) Standard Air Knife	20.4	577	11,000	55.9	2.7	77	83	30:1
6" (152mm) Full-Flow Air Knife	18.6	526	10,000	50.8	2.3	65	80	30:1

Velocity and force measured at 6" (152mm) from target. Sound level measured at 3' (914mm). All measurements taken at 80 PSIG (5.5 BAR).



## Standard Air Knife™

### Hard hitting curtain of air for web, sheet and part blowoff.

#### What Is The Standard Air Knife?

A quiet, energy efficient way to clean, dry or cool parts, webs or conveyors. The Standard Air Knife utilizes the Coanda effect (wall attachment of a high velocity fluid) to create air motion in its surroundings. Using a small amount of compressed air as a power source, the Standard Air Knife pulls in large volumes of surrounding air to produce a high flow, high velocity curtain of air for blowoff.

#### Why The Standard Air Knife?

Amplification ratios (entrained air to compressed air) of 30:1 are achieved with the Standard Air Knife, compared to 3:1 for drilled or slotted pipe. **Air savings of 40% to 90%** are possible when replacing these “homemade” blowoff devices. Pay-back is normally measured in weeks, not months or years.

The Standard Air Knife dramatically reduces “wind shear” by gradually introducing the entrained air to the ejected compressed air. **Noise level is typically cut in half.** The result is a high velocity, high volume sheet of air with reduced noise level and air consumption.

Drilled pipe or open jets, by contrast, provide minimal air amplification. They also produce unacceptably high noise levels as the compressed air shears into the still air.



(3) Model 2012 12" (305mm) Standard Air Knives perform the drying cycle in this parts washer.



A Model 2012 12" (305mm) Standard Air Knife opens mustard packets prior to fill.

#### Applications

- Part drying after wash
- Sheet cleaning in strip mills
- Conveyor cleaning
- Web drying or cleaning
- Part or component cooling
- Environmental separation
- Pre-paint blowoff
- Bag opening/fill operations
- Scrap removal on converting operations

#### Advantages

- Up to 10 dBA noise reduction
- Reduced air consumption
- 30:1 air amplification
- Aluminum or stainless steel
- Compact, rugged, easy to install
- Stock lengths to 48" (1219mm)
- No moving parts
- Compressed air inlets on each end
- Variable force and flow



# Standard Air Knife

## How The Standard Air Knife Works

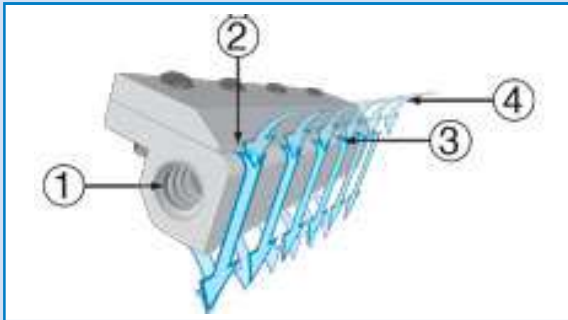

Compressed air flows through the inlet (1) into a plenum chamber. It is then throttled through a thin nozzle (2) extending the length of the Standard Air Knife. This primary airstream adheres to the Coanda profile (3), which turns it 90° and directs the flow down the face of the unit. The primary stream immediately begins to entrain surrounding air (4), for an amplification ratio of 30:1 at 6" (152mm) away.

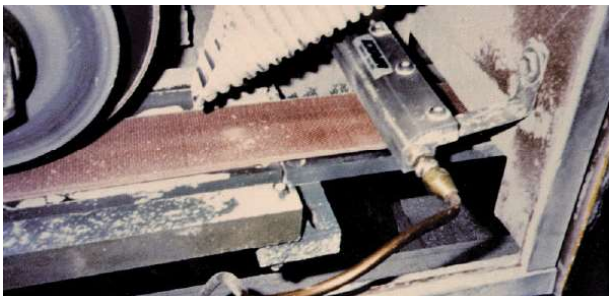

A Model 2006 6" (152mm) Standard Air Knife blows powder loose from a belt so it can be vacuumed away.



Kits include a Standard Air Knife, shim set, filter separator, and pressure regulator (with coupler).

### Standard Air Knife Performance with .002" (0.05mm) thick shim installed

Pressure Supply		Air Consumption per Inch (25mm)		Velocity @ 6" (152mm) from target		Sound Level @ 3' (914mm)	Force per Inch (25mm) @ 6" (152mm) from target	
PSIG	BAR	SCFM	SLPM	FPM	M/S	dBA	Ozs	Grams
20	1.4	1.3	37	4,000	20.3	65	0.45	13
40	2.8	2.0	57	5,800	29.5	74	1.1	31
60	4.1	2.7	76	8,500	43.2	80	2.0	57
80	5.5	3.4	96	11,000	55.9	83	2.7	77
100	6.9	4.1	116	13,000	66.0	86	3.3	94

12" (305mm) Standard Air Knife tested

## Standard Air Knife Specifications

The Standard Air Knife is available in ten standard lengths of 3", 6", 9", 12", 18", 24", 30", 36", 42" and 48" (76, 152, 229, 305, 457, 610, 762, 914, 1067 and 1219mm). This measurement refers to the airflow length. The overall length is 1" (25mm) longer. **Special lengths up to 48" (1219mm) are available.** Any number of Standard Air Knives may be installed across a given area.

**Compressed Air Inlets:** A Standard Air Knife has compressed air inlets on each end. Lengths 24" (610mm) and longer should be supplied with compressed air at each end to maintain uniform airflow.

**Filtration:** The use of clean air is essential. Kits include an automatic drain filter with a 5 micron filter element that is sized properly for flow.

**Materials of Construction:** The Standard Air Knife is available in either aluminum or stainless steel construction.

**Mounting:** See page 29 for complete details on the Universal Air Knife Mounting System. The Standard Air Knife can also be supported by the compressed air pipe.

**Regulation:** A pressure regulator on the compressed air supply provides infinite control of flow, force, and air consumption. Kits include a pressure regulator that is sized properly for flow.

**Shim Sets:** A Standard Air Knife has a .002" (0.05mm) gap setting. This gap is set with a shim positioned between the cap and body of the Standard Air Knife. Force and flow through the Standard Air Knife may be easily increased by adding shims to open the gap. Standard Air Knife Kits include a shim set (three additional shims). Shim sets for aluminum Standard Air Knives include a .001" (0.03mm) Amber color [■], .003" (0.08mm) Green color [■], and .004" (0.10mm) thick Tan color [■] plastic shims. Shim sets for stainless steel Standard Air Knives include (3) .002" (0.05mm) thick stainless steel shims.

# Standard Air Knife

## Standard Air Knife Dimensions

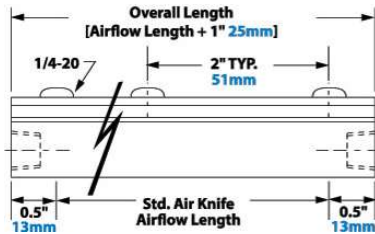

### Aluminum

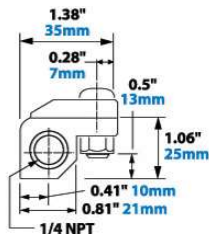

### Stainless Steel

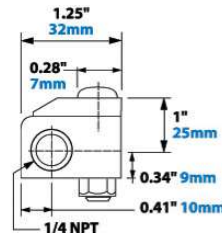

## Airflow Pattern

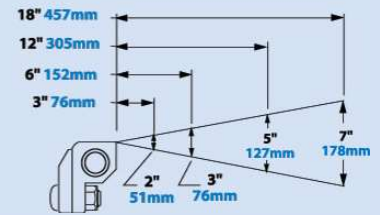

Standard Air Knife Only		
Airflow Length	Aluminum Model	Type 303SS Model
3" (76mm)	2003	2003SS
6" (152mm)	2006	2006SS
9" (229mm)	2009	2009SS
12" (305mm)	2012	2012SS
18" (457mm)	2018	2018SS
24" (610mm)	2024	2024SS
30" (762mm)	2030	2030SS
36" (914mm)	2036	2036SS
42" (1067mm)	2042	2042SS
48" (1219mm)	2048	2048SS

Standard Air Knife Kits		
Kits include a Standard Air Knife, shim set, filter separator and pressure regulator (with coupler).		
Airflow Length	Aluminum Model	Type 303SS Model
3" (76mm)	2203	2203SS
6" (152mm)	2206	2206SS
9" (229mm)	2209	2209SS
12" (305mm)	2212	2212SS
18" (457mm)	2218	2218SS
24" (610mm)	2224	2224SS
30" (762mm)	2230	2230SS
36" (914mm)	2236	2236SS
42" (1067mm)	2242	2242SS
48" (1219mm)	2248	2248SS

Accessories	
Model #	Description
9001	Auto Drain Filter Separator, 3/8 NPT, 65 SCFM (1,841 SLPM)
9032	Auto Drain Filter Separator, 1/2 NPT, 90 SCFM (2,549 SLPM)
9002	Auto Drain Filter Separator, 3/4 NPT, 220 SCFM (6,230 SLPM)
9066	Auto Drain Filter Separator, 1-1/4 NPT, 400 SCFM (11,327 SLPM)
9005	Oil Removal Filter, 3/8 NPT, 15-37 SCFM (425-1,048 SLPM)
9006	Oil Removal Filter, 3/4 NPT, 50-150 SCFM (1,416-4,248 SLPM)
9010	Oil Removal Filter, 1-1/2 NPT, 130-310 SCFM (3,679-8,773 SLPM)
9008	Pressure Regulator, 1/4 NPT, 50 SCFM (1,416 SLPM)
9033	Pressure Regulator, 1/2 NPT, 100 SCFM (2,832 SLPM)
9009	Pressure Regulator, 3/4 NPT, 220 SCFM (6,230 SLPM)
9067	Pressure Regulator, 1-1/4 NPT, 600 SCFM (16,990 SLPM)
9020	Solenoid Valve, 120V, 50/60Hz, 1/4 NPT, 40 SCFM (1,133 SLPM)
9034	NEMA 4/4X Solenoid Valve, 120V, 50/60Hz, 1/2 NPT, 100 SCFM (2,832 SLPM)
9036	NEMA 4/4X Solenoid Valve, 120V, 50/60Hz, 3/4 NPT, 200 SCFM (5,664 SLPM)
9065	NEMA 4/4X Solenoid Valve, 24VDC, 1 NPT, 350 SCFM (9,911 SLPM)



Deluxe Standard Air Knife Kits		
Kits include a Standard Air Knife, EFC, Universal Mounting System, shim set, filter separator and pressure regulator (with coupler).		
Airflow Length	Aluminum Model	Type 303SS Model
3" (76mm)	2203DX	2203SSDX
6" (152mm)	2206DX	2206SSDX
9" (229mm)	2209DX	2209SSDX
12" (305mm)	2212DX	2212SSDX
18" (457mm)	2218DX	2218SSDX
24" (610mm)	2224DX	2224SSDX
30" (762mm)	2230DX	2230SSDX
36" (914mm)	2236DX	2236SSDX
42" (1067mm)	2242DX	2242SSDX
48" (1219mm)	2248DX	2248SSDX

Standard Air Knife Shim Sets		
Shim Sets include (1) each of a .001" (0.03mm), .003" (0.08mm) and .004" (0.10mm) plastic shim. Stainless steel shim sets include (3) .002" (0.05mm) shims.		
Airflow Length	Aluminum Model	Type 303SS Model
3" (76mm)	2303	2303SS
6" (152mm)	2306	2306SS
9" (229mm)	2309	2309SS
12" (305mm)	2312	2312SS
18" (457mm)	2318	2318SS
24" (610mm)	2324	2324SS
30" (762mm)	2330	2330SS
36" (914mm)	2336	2336SS
42" (1067mm)	2342	2342SS
48" (1219mm)	2348	2348SS

Special length Standard Air Knives are available. Magnetic bases with Stay Set™ flexible hoses are also available for smaller Standard Air Knives. Please contact our factory.

## Universal Air Knife Mounting System

EXAIR's Universal Air Knife Mounting System allows for easy positioning of all EXAIR Air Knives. See page 29 for details.



# Full-Flow Air Knife



Air Knives

## Full-Flow Air Knife™

This low cost choice provides a curtain of air for blowoff, cleaning, drying and cooling.



### What Is The Full-Flow Air Knife?

EXAIR's Full-Flow Air Knife is an effective way to clean, dry or cool parts, webs or conveyors. It utilizes the Coanda effect to pull in large volumes of surrounding air, producing a high flow, high velocity curtain of air. The "Full-Flow" provides airflow across the entire length. A 12" (305mm) Full-Flow Air Knife measures 12" (305mm). It has the compressed air inlet(s) on the rear.

### Full-Flow Air Knife Specifications

The Full-Flow Air Knife is available in eight standard lengths of 3", 6", 9", 12", 18", 24", 30" and 36" (76, 152, 229, 305, 457, 610, 762 and 914mm). **Special lengths up to 36" (914mm) and unlimited system lengths are available.**

**Compressed Air Inlet(s):** A Full-Flow Air Knife has the compressed air inlet(s) on the rear. Inlets are available on each end at a small additional charge, however, they are not recommended for applications where uniform airflow across the length is required.

**Filtration:** The use of clean air is essential. Kits include an automatic drain filter with a 5 micron filter element that is sized properly for flow.

**Materials of Construction:** The Full-Flow Air Knife is available in either aluminum or stainless steel construction.

**Mounting:** See page 29 for complete details on the Universal Air Knife Mounting System. The Full-Flow Air Knife can also be supported by the compressed air pipe.



Kits include a Full-Flow Air Knife, shim set, filter separator and pressure regulator (with coupler).

**Regulation:** A pressure regulator on the compressed air supply provides infinite control of flow, force, and air consumption. Kits include a pressure regulator that is sized properly for flow.

**Shim Sets:** A Full-Flow Air Knife has a .002" (0.05mm) gap setting. This gap is set with a shim positioned between the cap and body of the Full-Flow Air Knife. Force and flow through the Full-Flow Air Knife may be easily increased by adding shims to open the gap. Kits include a shim set. Shim sets for aluminum Full-Flow Air Knives include a .001" (0.03mm) **Amber color** [■], .003" (0.08mm) **Green color** [■], and .004" (0.10mm) **Tan color** [■] plastic shims. Shim sets for stainless steel Full-Flow Air Knives include (1) .002" (0.05mm) thick stainless steel shim.

### Full-Flow Air Knife Performance with .002" (0.05mm) thick shim installed



Pressure Supply		Air Consumption per Inch (25mm)		Velocity @ 6" (152mm) from target		Sound Level @ 3' (914mm)	Force per Inch (25mm) @ 6" (152mm) from target	
PSIG	BAR	SCFM	SLPM	FPM	M/S	dBA	Ozs	Grams
20	1.4	1.1	31	3,000	15.2	64	0.4	11
40	2.8	1.8	51	5,000	25.4	72	1.0	28
60	4.1	2.4	68	7,500	38.1	76	1.6	45
80	5.5	3.1	88	10,000	50.8	80	2.3	65
100	6.9	3.8	108	12,000	61.0	83	2.9	82

12" (305mm) Full-Flow Air Knife tested

# Full-Flow Air Knife



A series of Full-Flow Air Knives “float” layers of plastic film in the confined space of the machine.

## Full-Flow Air Knife Dimensions

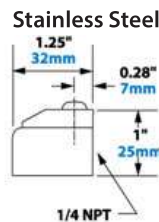
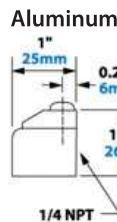
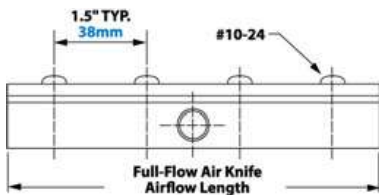

## Airflow Pattern

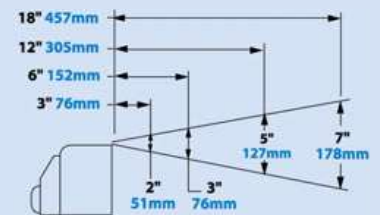

## Accessories

Model #	Description
9001	Auto Drain Filter Separator, 3/8 NPT, 65 SCFM (1,841 SLPM)
9032	Auto Drain Filter Separator, 1/2 NPT, 90 SCFM (2,549 SLPM)
9002	Auto Drain Filter Separator, 3/4 NPT, 220 SCFM (6,230 SLPM)
9005	Oil Removal Filter, 3/8 NPT, 15-37 SCFM (425-1,048 SLPM)
9006	Oil Removal Filter, 3/4 NPT, 50-150 SCFM (1,416-4,248 SLPM)
9008	Pressure Regulator, 1/4 NPT, 50 SCFM (1,416 SLPM)
9033	Pressure Regulator, 1/2 NPT, 100 SCFM (2,832 SLPM)
9009	Pressure Regulator, 3/4 NPT, 220 SCFM (6,230 SLPM)
9020	Solenoid Valve, 120V, 50/60Hz, 1/4 NPT, 40 SCFM (1,133 SLPM)
9034	NEMA 4/4X Solenoid Valve, 120V, 50/60Hz, 1/2 NPT, 100 SCFM (2,832 SLPM)
9036	NEMA 4/4X Solenoid Valve, 120V, 50/60Hz, 3/4 NPT, 200 SCFM (5,664 SLPM)
9065	NEMA 4/4X Solenoid Valve, 24VDC, 1 NPT, 350 SCFM (9,911 SLPM)

### Full-Flow Air Knife Only

Airflow Length	Aluminum Model	Type 303SS Model
3" (76mm)	2603	2603SS
6" (152mm)	2606	2606SS
9" (229mm)	2609	2609SS
12" (305mm)	2612	2612SS
18" (457mm)	2618	2618SS
24" (610mm)	2624	2624SS
30" (762mm)	2630	2630SS
36" (914mm)	2636	2636SS

### Full-Flow Air Knife Kits

Kits include a Full-Flow Air Knife, shim set, filter separator and pressure regulator (with coupler).

Airflow Length	Aluminum Model	Type 303SS Model
3" (76mm)	2803	2803SS
6" (152mm)	2806	2806SS
9" (229mm)	2809	2809SS
12" (305mm)	2812	2812SS
18" (457mm)	2818	2818SS
24" (610mm)	2824	2824SS
30" (762mm)	2830	2830SS
36" (914mm)	2836	2836SS

**ORDER ONLINE**  
at EXAIR.com

### Deluxe Full-Flow Air Knife Kits

Kits include a Full-Flow Air Knife, EFC, Universal Mounting System, shim set, filter separator and pressure regulator (with coupler).

Airflow Length	Aluminum Model	Type 303SS Model
3" (76mm)	2803DX	2803SSDX
6" (152mm)	2806DX	2806SSDX
9" (229mm)	2809DX	2809SSDX
12" (305mm)	2812DX	2812SSDX
18" (457mm)	2818DX	2818SSDX
24" (610mm)	2824DX	2824SSDX
30" (762mm)	2830DX	2830SSDX
36" (914mm)	2836DX	2836SSDX

### Full-Flow Air Knife Shim Sets

Shim Sets include (1) each of a .001" (0.03mm), .003" (0.08mm) and .004" (0.10mm) plastic shim. Stainless Steel Shim Sets include (1) .002" (0.05mm) thick shim.

Airflow Length	Aluminum Model	Type 303SS Model
3" (76mm)	2903	2903SS
6" (152mm)	2906	2906SS
9" (229mm)	2909	2909SS
12" (305mm)	2912	2912SS
18" (457mm)	2918	2918SS
24" (610mm)	2924	2924SS
30" (762mm)	2930	2930SS
36" (914mm)	2936	2936SS

**Special length Full-Flow Air Knives and unlimited system lengths are available. Magnetic bases with Stay Set™ flexible hoses are also available for smaller Full-Flow Air Knives.**

Please contact our factory.

Inlets on each end are available at a small charge. This is not recommended if uniform flow is desired. Please contact one of our Application Engineers for details.

## Universal Air Knife Mounting System



EXAIR's Universal Air Knife Mounting System allows for easy positioning of all EXAIR Air Knives. See page 29 for details.